

9000 Lm Street Light Spec Sheet

S3 Series



IP66



P/N	S3090X-001*	S3175X-001*
Picture		
Rated Lumen**	9000 lm (Measured value:9073.8 lm)	17500 lm (Measured value:17580.3 lm)
Rated Voltage	100~240V, 50/60HZ	
Power Factor	>0.95	
Lighting Efficacy**	119.1 lm/W	117.3 lm/W
Rated Power	75W	150W
Color Temp	5000K / 3000K	
CRI	>80	>80
Beam Angle	140° x 75°	
Central lux@6500K (1M/2M/3M)	2745Lx/ 686Lx/ 305Lx	5041Lx/ 1260Lx/ 560Lx
Dimension(±2mm)	431mm(L)x 160mm(W)x89mm(H)	632mm(L)x 215mm(W)x90mm(H)
Weight(±5%)	3200g	5100g

* X Can be replaced by C:5000K/ W:3000K.

**The value is measured at 5000K.

Content

1 · Introduction	3
2 · Features	3
3 · Application	3
4 · Dimensions	4
5 · Photometry	5
6 · Operation Condition	6
7 · Specification	6
8 · Packing	7
9 · Wiring and Installation Instruction	8
11. Out-Door Wiring for Water-Proof	9
10. Warranty	10



Introduction

【 S3090 】 9000Lm LED Out-Door Street light is a revolutionary product, its higher efficacy (115Lm/W) and powered by Meanwell(ELG) provides a better energy saving solution, longer product life time, and good stability(IP66) in out-door environment.

Features

1. Use fin-structure aluminum housing for excellent thermal dissipation and light weight.
2. Using high efficacy LED module to perform 115 steady lighting lumen per wattage.
3. Higher color rendering, CRI>80 with R9>0
4. IP66 waterproof level.
5. Testing report ready by TAF lab (IP66 and light density distribution for 5000K)
6. Easy to install.
7. Meet RoHS standard.

Application

1. Landscape lighting
2. Sidewalk lighting



Dimension

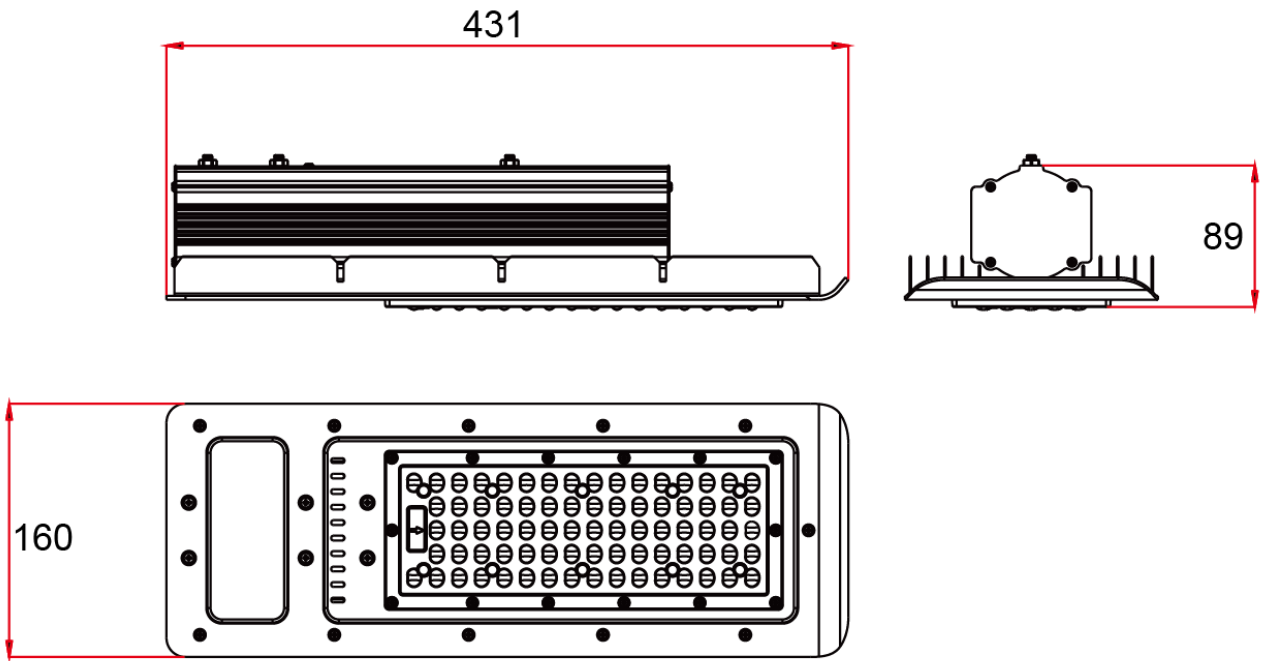

unit : mm

Photometry

Central Lux 5000K@220V

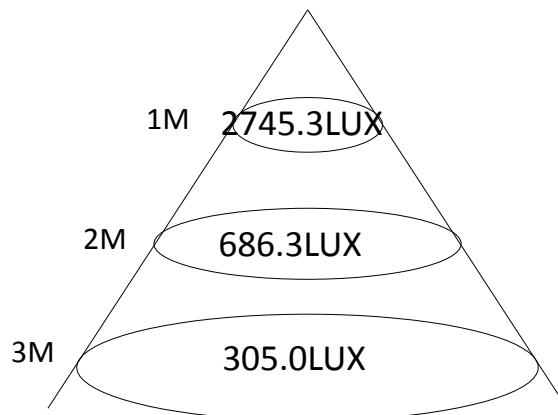

Photometry

S3090C-001 @220V

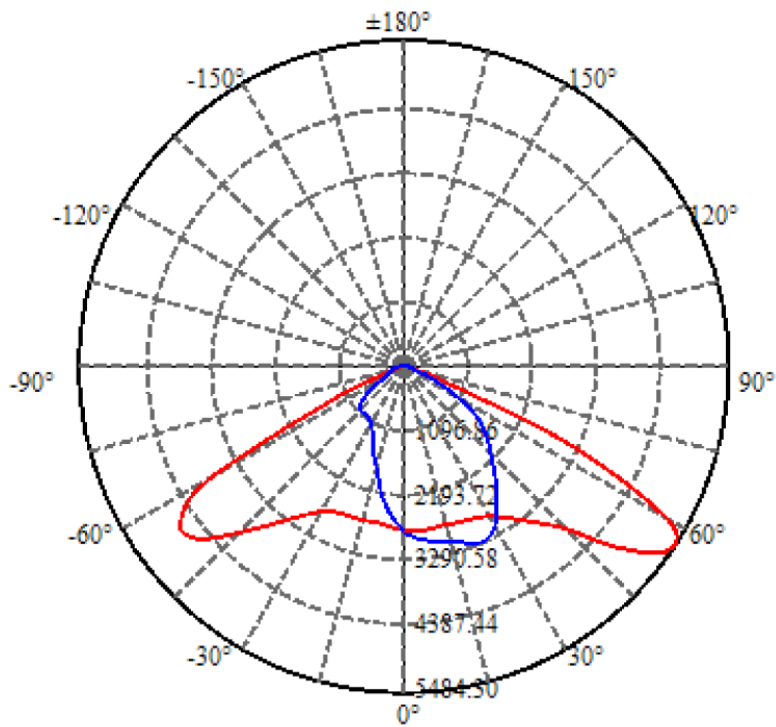

Isocandela diagram

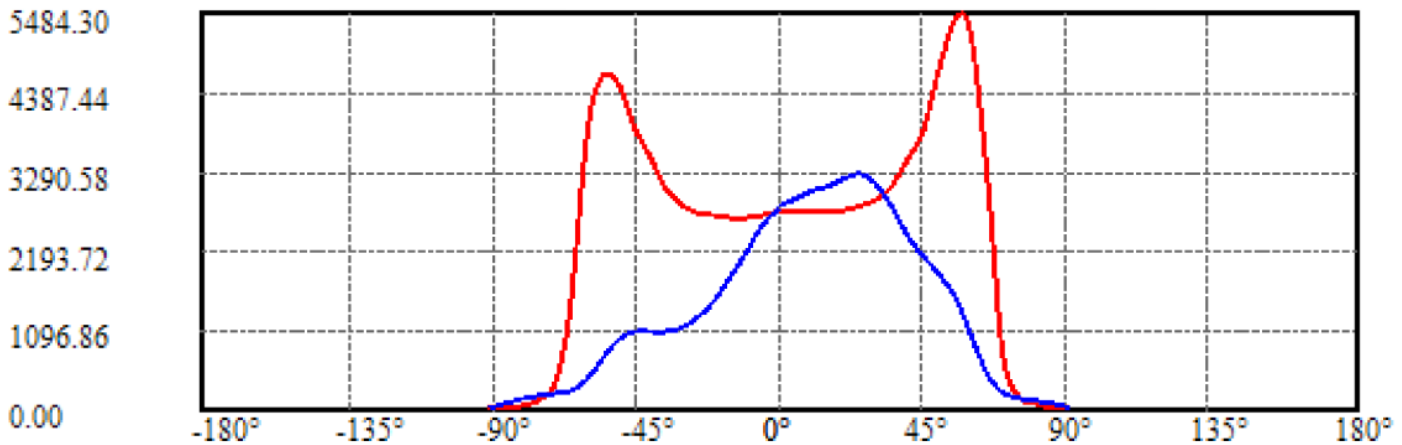
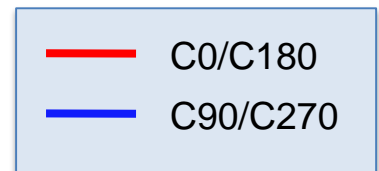

Cartesian coordinates

Operation Condition

Input voltage : 100~240V / 50/60Hz

Operation ambient temperature : -30°C to +40 °C

Storage temperature : -40°C to +60 °C

Specification

Parameter	Rating	Unit
AC Input Voltage	100~240	VAC
Frequency	50/60	Hz
Operation Ambient Temperature	-30 to+40	°C
Color Temperature	5000 / 3000	K
Rated Lumen	9000(Measured value:9073.8)	lm
Lighting Efficacy	119.1	lm/W
CRI	>80	
Dimension(±2mm)	431(L)x 160(W)x89(H)	mm
Weight(±5%)	3200	g
Lifetime	40000	hour
Beam Angle	140 x 75	degree

- Notes:** 1. Luminous flux is measured at 5000K and with an accuracy of ±10%.
2. Luminous flux is measured at TA= 25°C and reaches thermal equilibrium.



Packaging

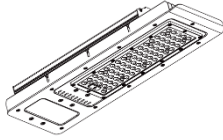

47(L)*22(W) *14.5(H)

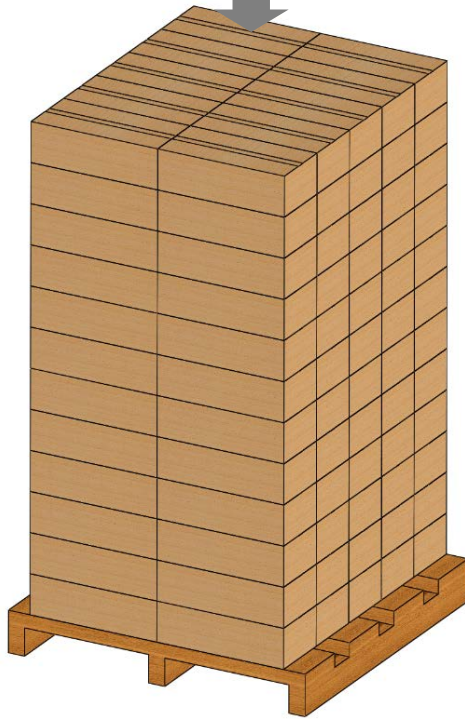

1 layer= 10 ea total 12 layers

1 pallet= 120ea S3090

Pallet dimension: 110*110*13

unit: cm



Wiring and Installation Instruction

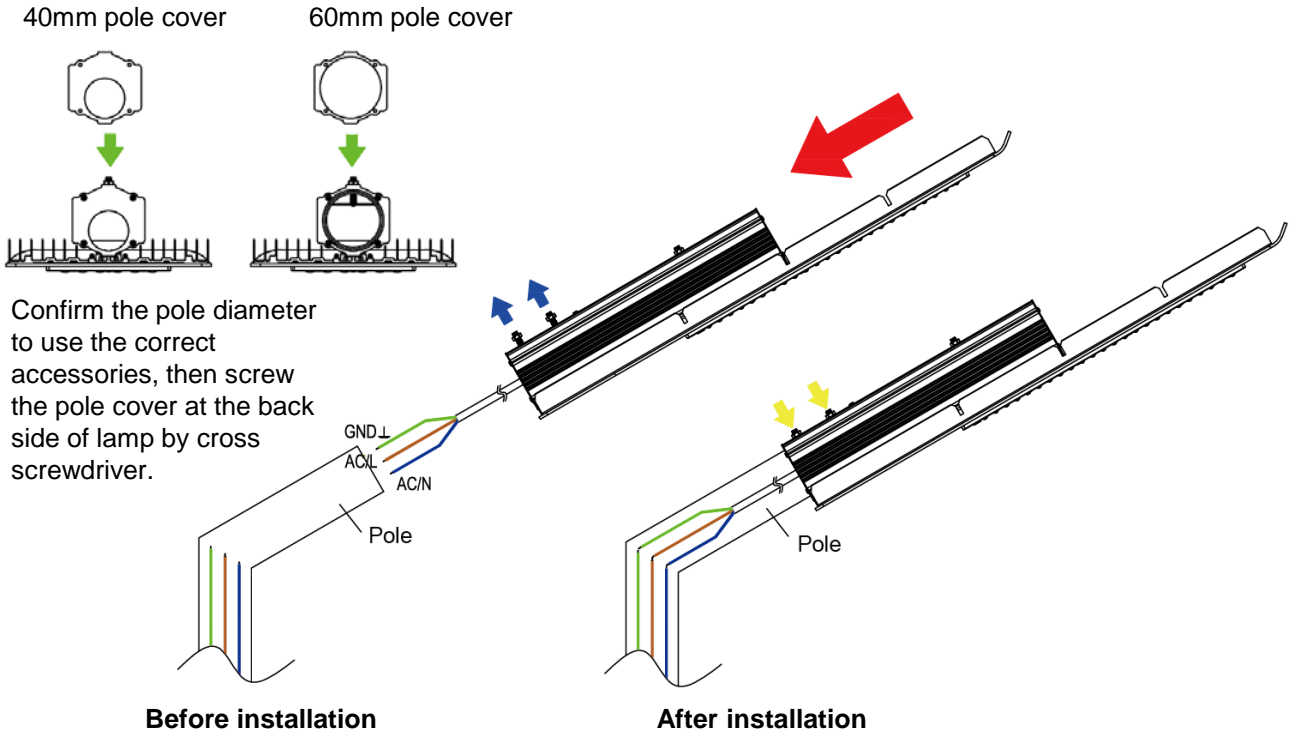

Wiring Instruction :

1. Install lamp by the professional person with electrical license.
2. Make sure the power is off before installation.
3. Make sure no high power-consumption equipments nearby the lamp (e.g., elevator, refrigerator, air-conditioner). It will generate surge that may damage the lamp while start up.
4. Connect blue cord of lamp to AC/N; brown cord to AC/L.
5. Connect ground cord of lamp(yellow/green) to ground.
6. DO NOT use any tools to disassemble or repair lamps.
7. Products are available for AC 100V~240V, 50/60Hz. DO NOT install lamp to the environment out of the range.

Installation Instruction :

1. Follow the blue arrow to unscrew the bolts and nuts by hexagon key in a counterclockwise direction before installation.
2. Confirm the pole diameter to choose the correct pole cover (40 mm or 60 mm) before installation. Then screw it at the back side of lamp.
3. Connect the power cords of lamp with AC power cords inside the pole before install the lamp on the pole.
4. Follow the red arrow to push the lamp into the pole.
5. Follow the yellow arrow to screw the bolts tight by hexagon key, then tight nuts by wrench in a clockwise direction.
6. Make sure the screws are tight and the lamp are fixed firmly with the pole.







Out-Door Wiring for Water-Proof

Caution:

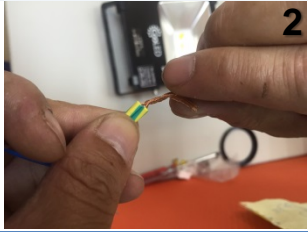
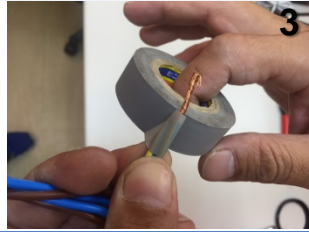
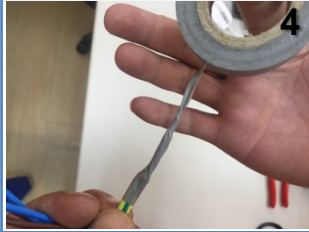
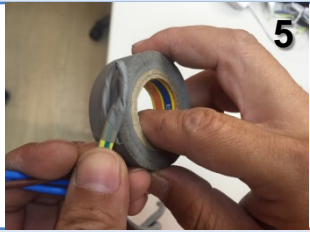
1. Read the instruction carefully before wiring.
2. Make sure the power is off before installation.
3. Make sure no high power-consumption equipments nearby the lamp (e.g., elevator, refrigerator, air-conditioner). It will generate surge that may damage the lamp while start up.
4. Non-professional staff shall not use any tools to disassemble or repair lamps.
5. Products are available for AC 100V~240V, 50/60Hz. DO NOT install lamp to the environment out of the range.

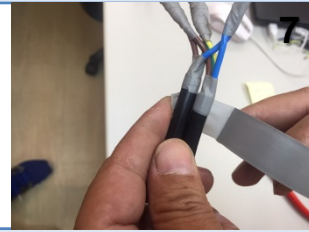
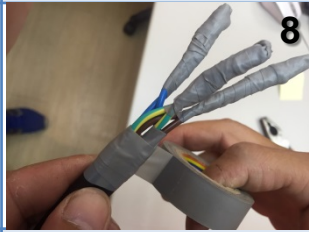
Note: Emergency handling: Turn off the power when the lamp is abnormal.

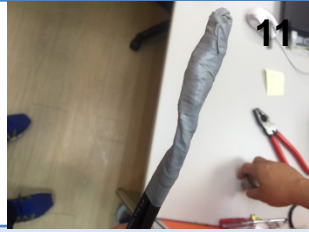
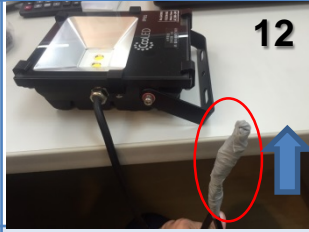
 <p>1</p>	 <p>2</p>	 <p>3</p>	 <p>4</p>
<p>Tie the 3-cord cable of lamp by insulation tape to cover all branch area for water-proof. Same as the cable of AC side.</p>	<p>Twist bare wires of lamp ground cord and AC ground cord together at the same direction. Same as live cords(L) and neutral cords(N).</p>	<p>Fold up the front end of bare wires to prevent tape falling off. Then cover it by isolation tape.</p>	<p>Continue winding bare wires by tape. It should be over the front end of bare wires 4 to 8 cm.</p>
 <p>5</p>	 <p>6</p>	 <p>7</p>	 <p>8</p>
<p>Pull the surplus tape back to prevent bare area from getting vapor.</p>	<p>Repeat step 4 and 5 at least 3 times. Refer to Electrical Engineering Rules about winding methods and standards.</p>	<p>Make sure 3 groups of wires are covered by tape firmly, then start to wind the tape from the branch point of two main cords.</p>	<p>Keep winding the tape and ensure two main cords covered by tape firmly.</p>
 <p>9</p>	 <p>10</p>	 <p>11</p>	 <p>12</p>
<p>Continue winding 3 groups of wires by tape. It should be over the front end of bare wires 10 to 15 cm.</p>	<p>Pull the surplus tape back to prevent bare area from getting vapor.</p>	<p>Repeat step 8 and 9 at least 3 times. Refer to Electrical Engineering Rules about winding methods and standards.</p>	<p>Fold up the cords with tape and face up. The cord position has to lower than lamp, or vapor will follow the cords into the lamp when it rains.</p>

Note: Turn off the power during wiring to prevent lamp damage because of abnormal wiring.



Warranty

We offer **two-year limited warranty** on the entire system.

1. Under normal condition with no mechanical damage or LED light module disassembly, LED lumen degradation is within 30%. (Under the environment of room temperature 25°C, the LED life maybe more than 50000 hr)
2. Warranty does not provide coverage for product damage resulting from the end user's failure to replace surge protection devices before they have reached their useful life.
3. Warranty does not provide coverage for product damage resulting from the natural disasters like typhoon, flood etc.
4. CoolLED is not responsible for the product which is transformed or dismantled without permission.

We reserve the right to modify, and/or to withdraw any part of data sheet herein.

